



Data:	04.04.2019	Nr dok. 1.2
Temat:	Komunikat nr 2	godz. 14.00
Od:	Dyrektora Rajdu	Liczba stron: 1
Do:	Zawodników nr 24,28,32,34,36,46,47,48,49,50,51, 52,54,55,57,59,60,61,62	Załączniki: 1

Ustanawia się nową lokalizację parku serwisowego , plan sytuacyjny parku oraz wynikające z tego zmiany w Księżce Drogowej w załączniku nr 1

Zatwierdzono przez OKSS w dniu 04.04.2019
Przewodniczący OKSS
Sebastian Oćwieja

Dyrektor Rajdu
Paweł Owczyński

Załącznik nr1

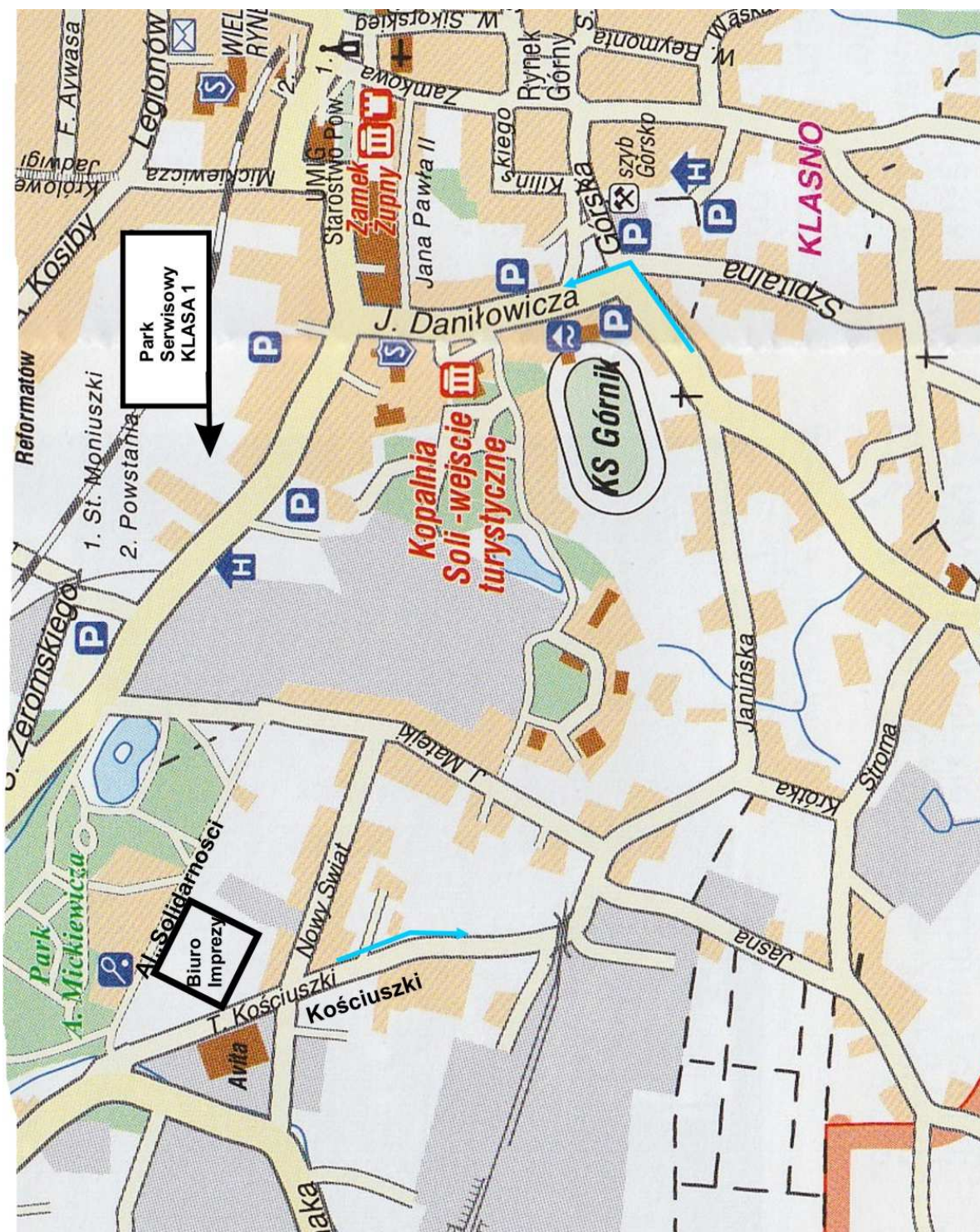



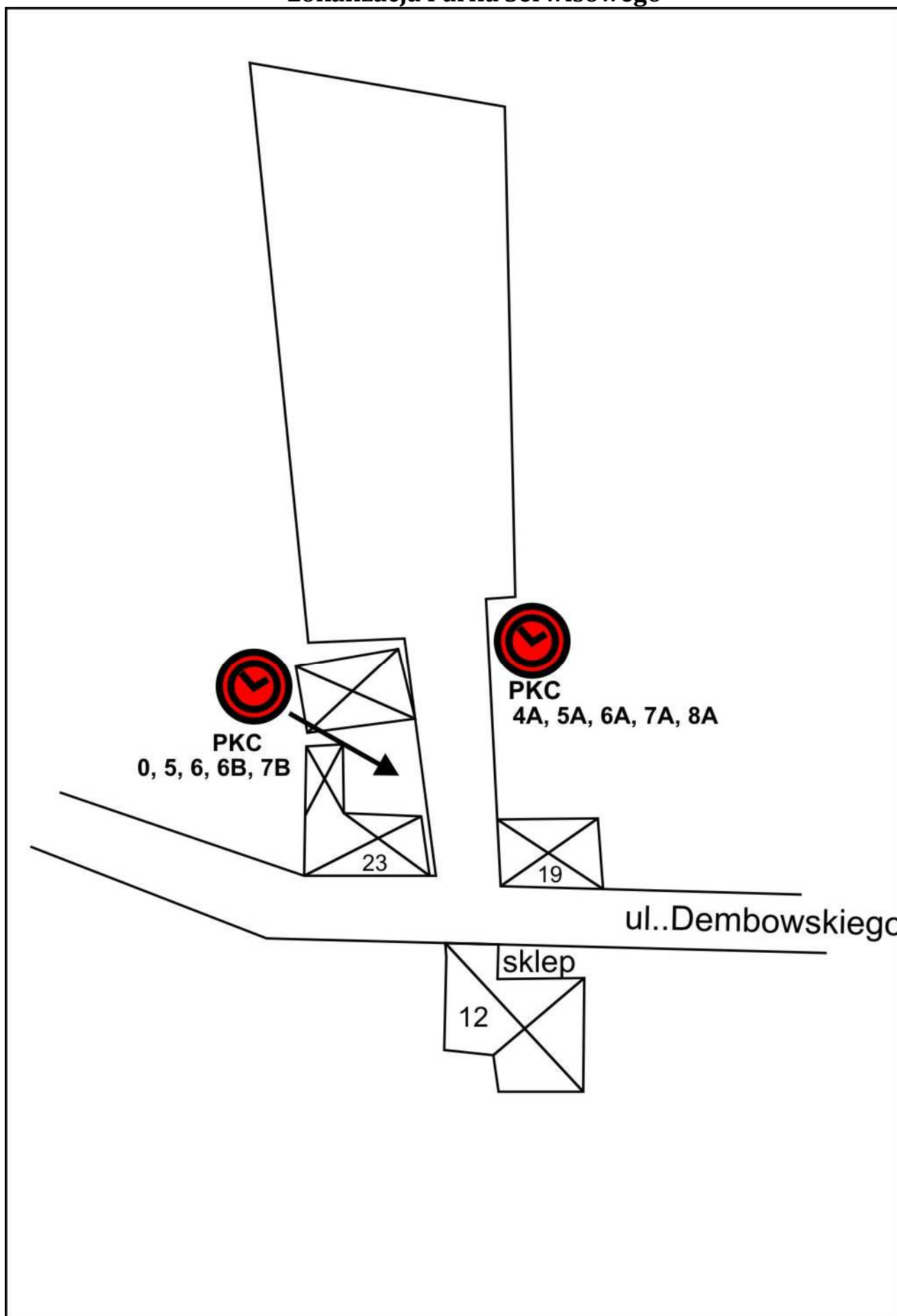

Lokalizacja Parku Serwisowego



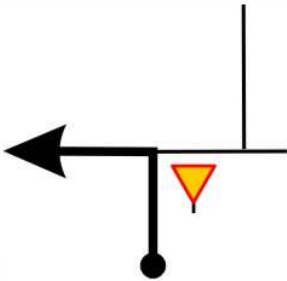

jest

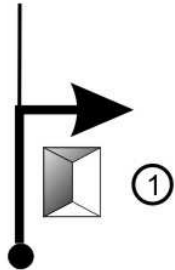
strona 11

0,00	0,00	1		 0	18,45
0,05	0,05	2			18,40
0,21	0,16	3		① Urząd Miasta i Gminy	18,24

ma być

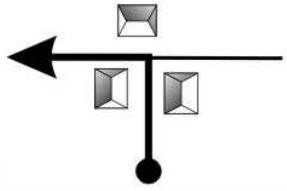
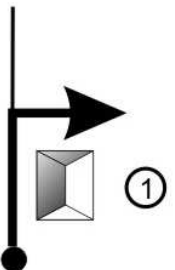
0,00	0,00	1		 0	18,62
0,04	0,04	2			18,58
0,38	0,34	3		① Urząd Miasta i Gminy	18,24

jest

28,53	0,23	1			0,06
28,59	0,06	2		 4A	0,00

ma być

28,53	0,23	1			0,21
28,70	0,17	2			0,04
28,74	0,04	3		 4A	0,00

ma być

strona 53 i 61

PKC4A,5AWieliczka - serwis wjazd	Odległość 0,15 km	Etap	1	Strona
PKC 5, 6 Wieliczka - serwis wyjazd		Sekcja	2	
Odcinek specjalny	Prędkość śr. km/h	Czas przejazdu ~ 66 min.		

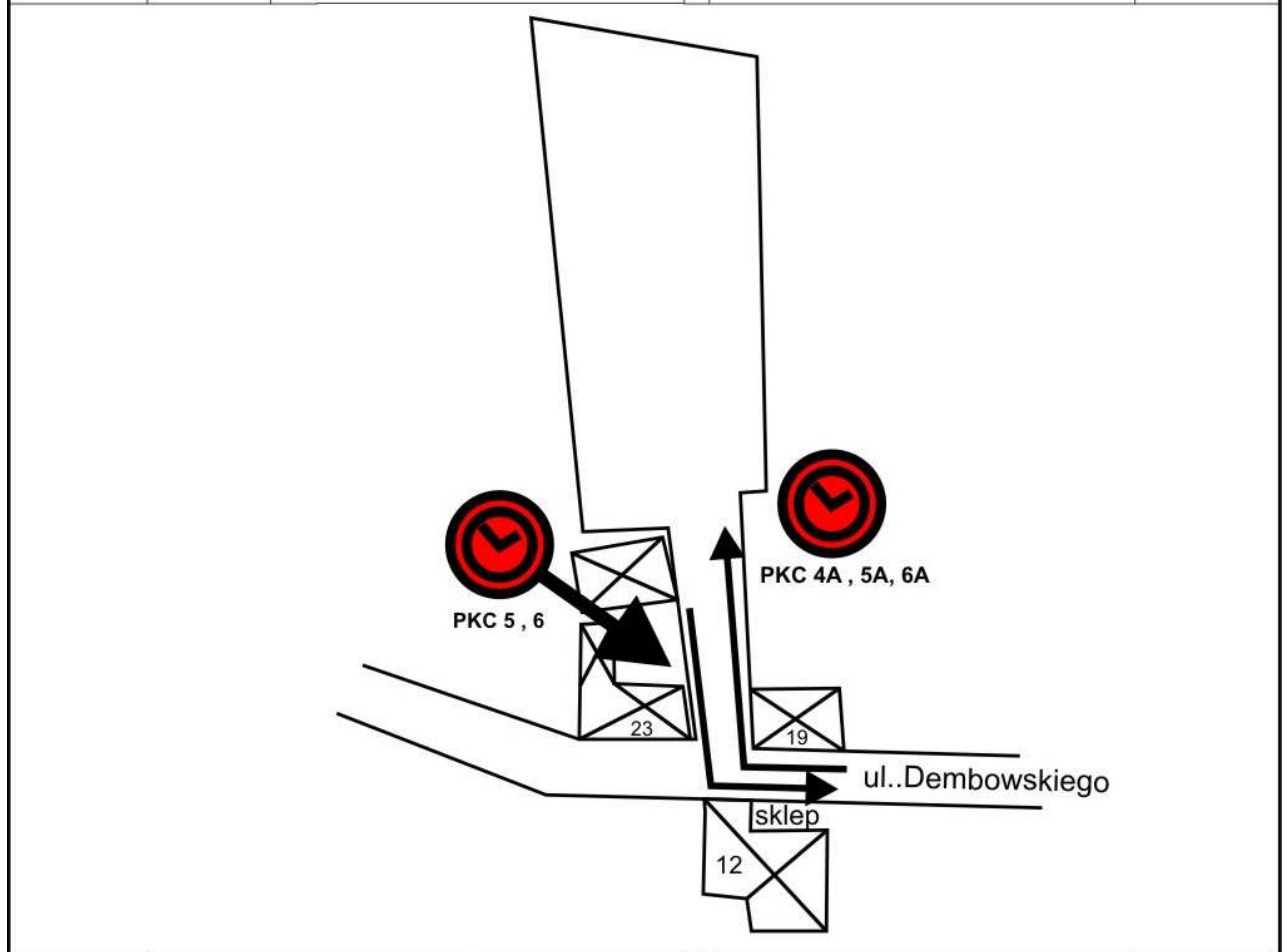

Odległość		Kierunek	Informacja	km do PKC
Etapu	Odcinka			
0,00	0,00	↑	 4A 5A	0,15
		1		



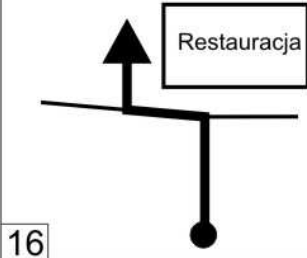
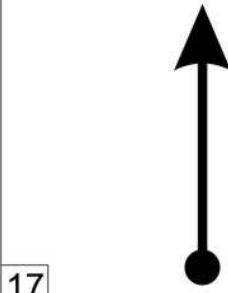

0,15	0,15	↑	 5 6	0,00
		2		

jest

strona 60 i 66

2,16	0,26			0,03
2,19	0,03		 5A 6A	0,00

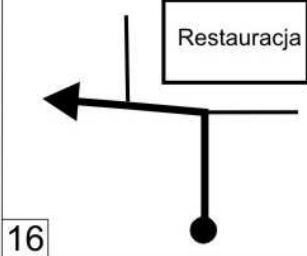
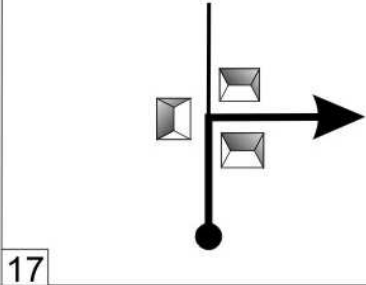
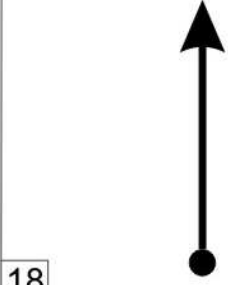
ma być

2,16	0,26			0,21
2,33	0,17			0,04
2,37	0,04		 5A 6A	0,00



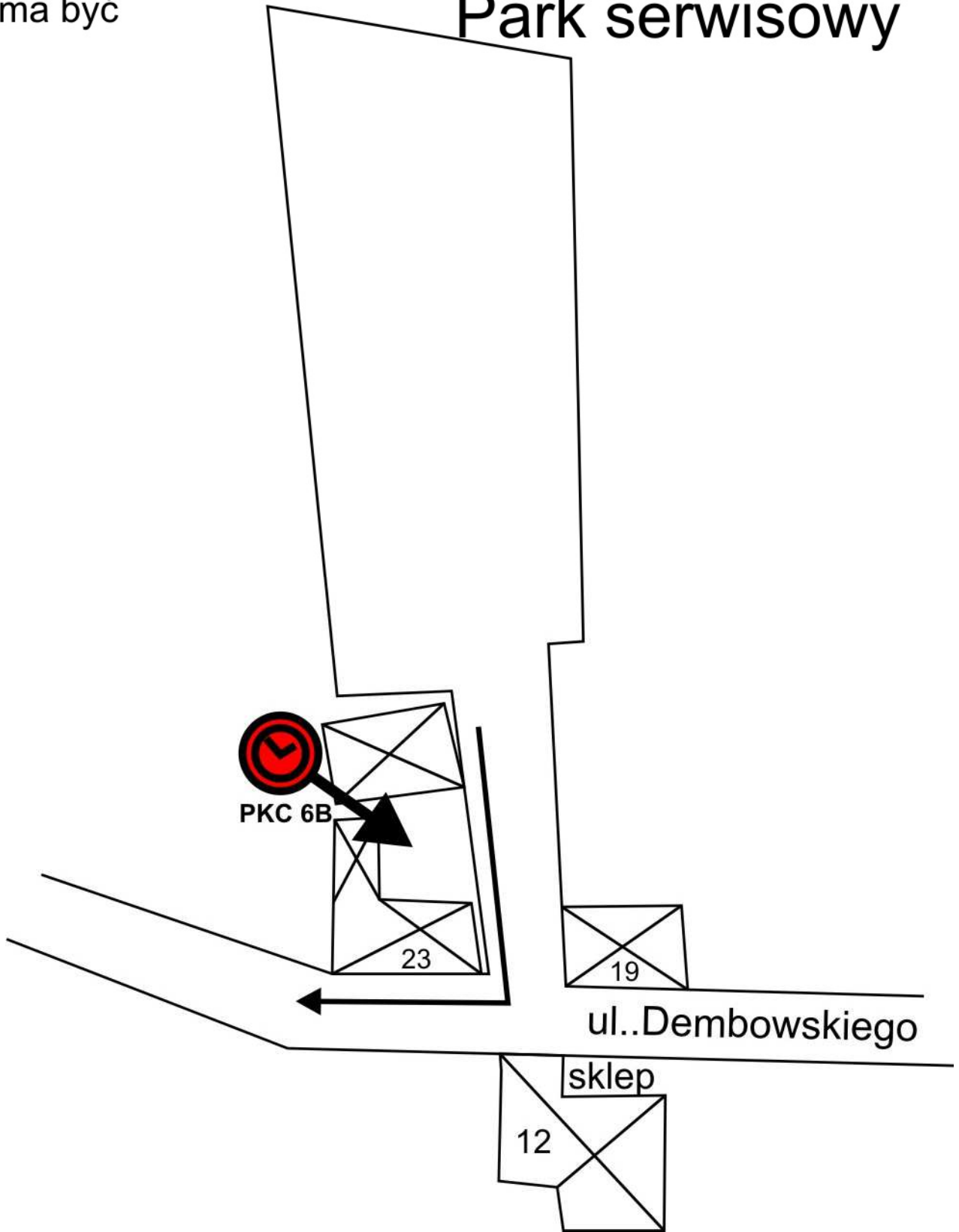

ma być

Park serwisowy



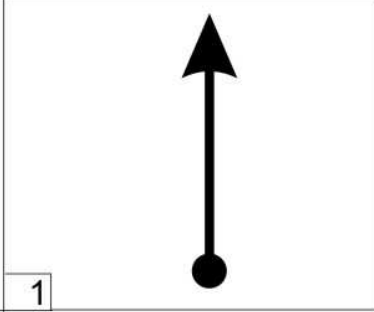

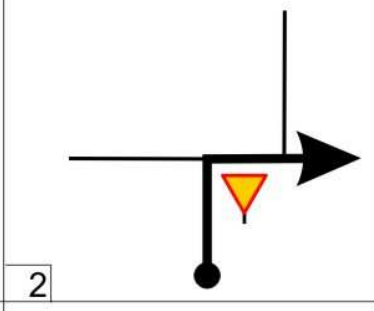
jest

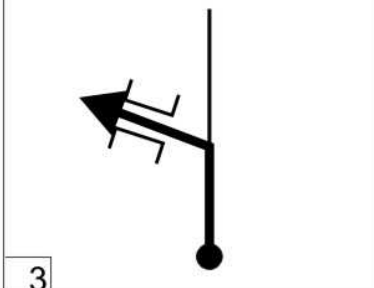
strona 69 i 79

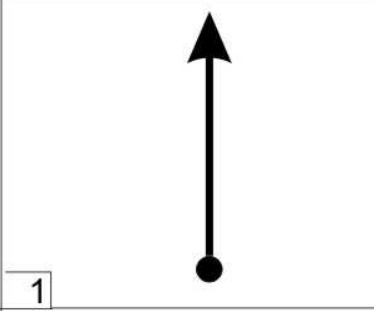

0,00	0,00		 6B 7B	1,04
0,05	0,05			0,99
0,58	0,53			0,46

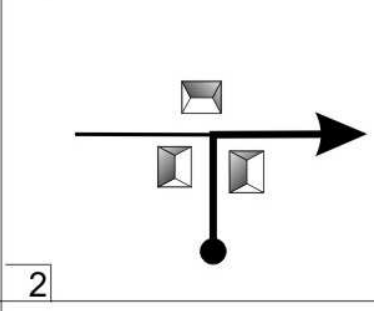
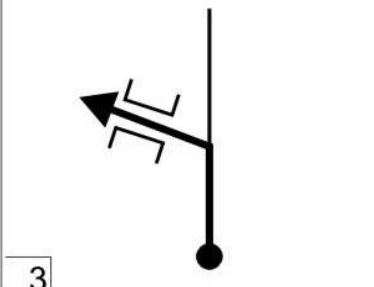
ma być



0,00	0,00		 6B 7B	0,83
0,04	0,04			0,79
0,37	0,33			0,46

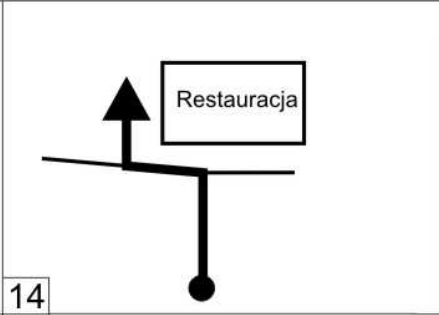
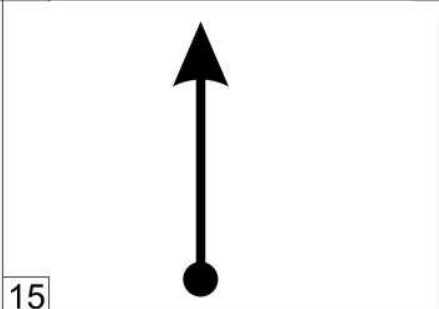

jest

strona 75 i 83

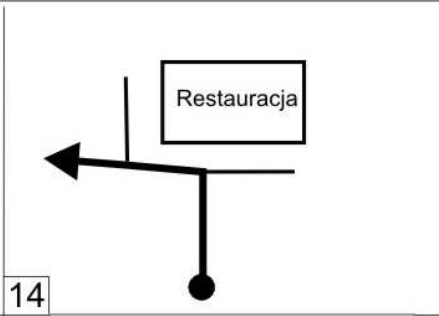
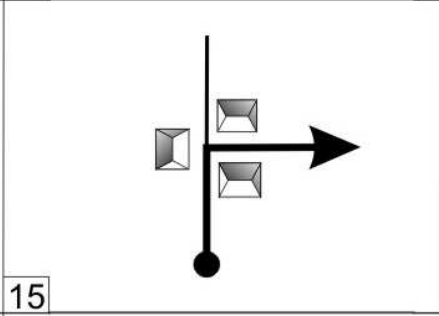
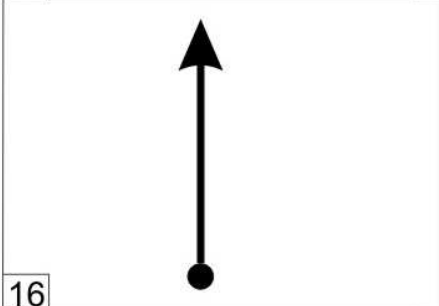
2,16	0,26			0,03
2,19	0,03		 7A 8A	0,00

ma być

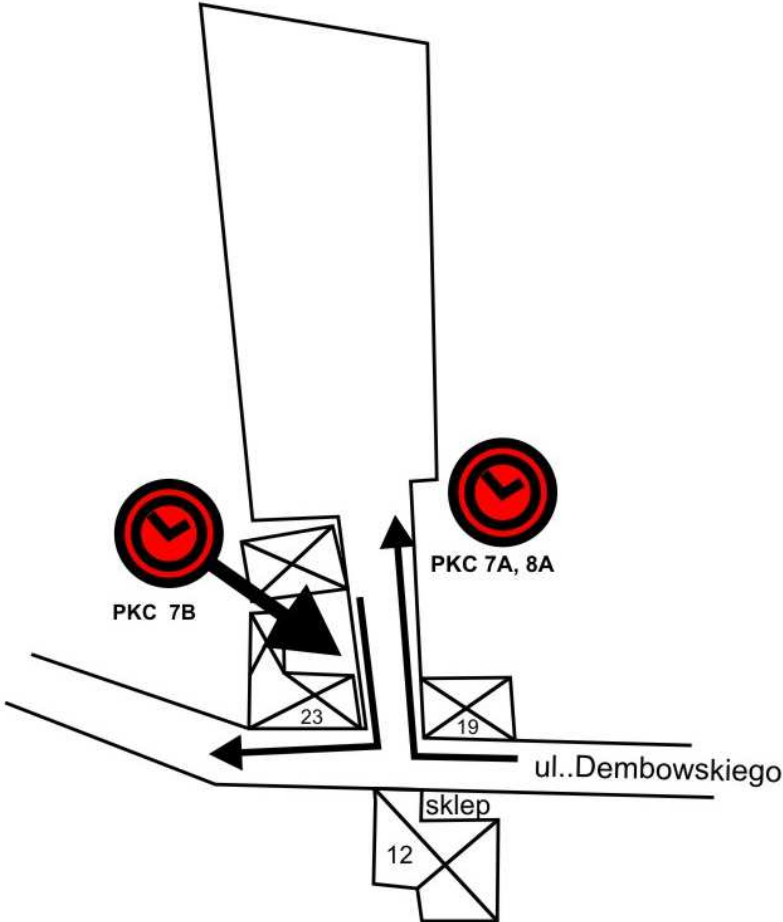
2,16	0,26			0,21
2,33	0,17			0,04
2,37	0,04		 7A 8A	0,00

PKC 7A Wieliczka-serwis wjazd		Odległość 0,15 km	Etap	1	Strona 53
PKC 7B Wieliczka-serwis wjazd			Sekcja	3	
Odcinek specjalny		Prędkość śr. km/h	Czas przejazdu ~ 66 min.		
Odległość		Kierunek	Informacja		km do PKC
Etapu	Odcinka				
0,00	0,00	↑	 7A		0,15
		●			1
					
0,15	0,15	↑	 7B		0,00
		●			2